

MODEL RS

CABLE OPERATED SAFETY STOP SWITCH FOR CONVEYORS

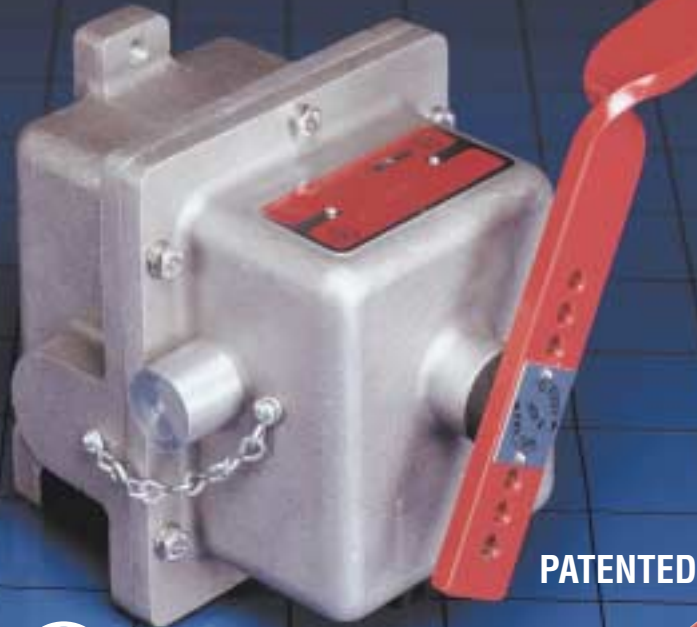

The model RS Safety Stop Switch in operation for immediate shutdown of conveyor system at a sand and gravel company.

EXCLUSIVE FEATURES

1. The Model RS is equipped with a positive safety lock. Having once been actuated, it cannot be accidentally reset causing dangerous equipment to restart. In order to reset the switch, the actuation arm must be pushed in and turned. It takes no longer and it makes this a true "safety" switch.
2. The Model RS is installed with cable extending in both directions from the actuating handle. There is one electrical connection inside. This simple arrangement eliminates the double electrical connections required in two ended units employing a separate micro switch for cable in each direction.
3. The actuation force required is simply adjusted in the field by a change in the position of the cable in holes provided in the actuation arm. One of our units will handle as much cable length as a double ended competitive unit and there is no longer a need to specify actuating force or right or left handed units.
4. The standard construction of the unit is a corrosion resistant aluminum housing complete with stainless steel hardware and red powder coated actuation handle. The actuation shaft is of stainless steel. Powder coated cast iron construction is available if necessary. Epoxy coating of either casting is also available if required.
5. The Model RS controls are listed by Underwriters Laboratories, Inc. and Canadian Standards Association. The general purpose models are listed for non hazardous atmospheres. Explosion proof models are listed for use in hazardous atmospheres as defined by the National Electric Code handbook and the National Electrical Manufacturers Association Standards for NEMA 7 and 9 hazardous locations. Specifically, they are listed for Class I, Groups C and D; and Class II, Groups E, F, and G.
6. Model RS offers the lowest cost per foot of protection because it incorporates fewer switches and less wiring is required. Cable may be extended in either or both directions with no changes required in the internal mechanism of the unit and the wiring is still of a simple uncomplicated nature.
7. The switch is available with a warning light that may be wired to indicate actuation. This permits easy identification of actuated switches in areas where visual identification is difficult.

SHOWN TO THE RIGHT IS THE MODEL RS WITH THE BROKEN CABLE OPTION. THIS FEATURE ENSURES ACTUATION EVEN IF THE CABLE IS BROKEN OR CUT.



WHAT IT IS AND DOES:

The Model RS is a rugged safety switch that provides a quick positive shut off of dangerous equipment in emergencies or normal operation. It is actuated by a cable pulled by endangered personnel. The output contacts of the Model RS can control up to two separate circuits, one for machinery shutdown and one for alarm.

WHY IS IT NECESSARY?

Safety minded operators of conveyors, production lines, elevator equipment, assembly lines, material handling systems, cranes, etc. consider it a must for employee protection. Most states have safety statutes that require these switches on conveyor and related equipment. American National Standard Institute recommends their use in ANSI standard No. ASME B20.1 - 1993-5.11. This ANSI standard will probably soon become part of the Williams-Steiger Act of 1970-the OSHA Act.

UL Listed for General Purpose and EXPLOSION PROOF Environments . . . the only switch of its kind to meet these requirements

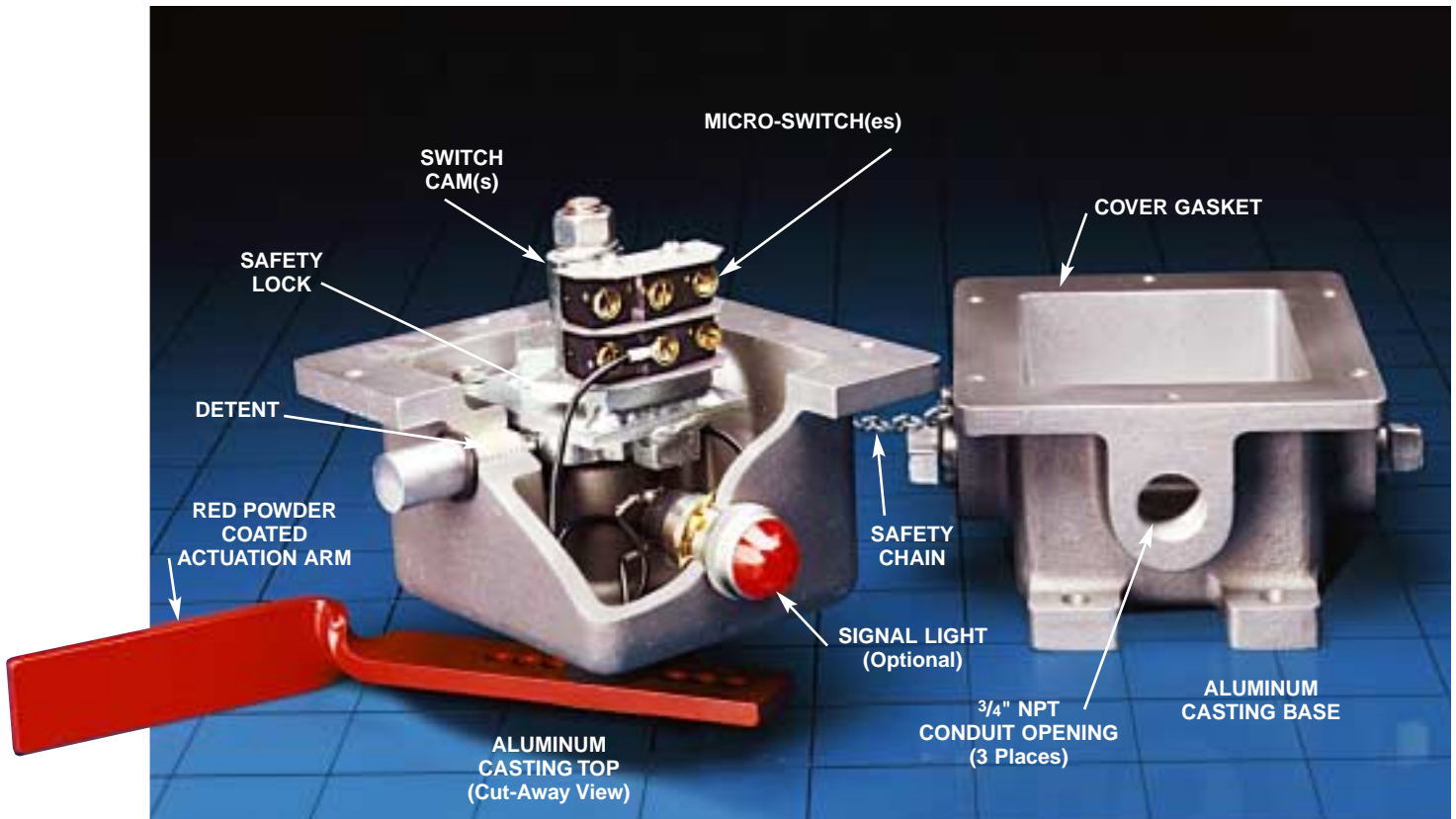

OPERATION OF THE UNIT:

The unit is usually installed with cable running in both directions from the crank type actuating arm. Each of the two sections of cable runs to a fixed point through eye-bolts spaced at regular intervals.

A pull on the cable at any point along its run will rotate the red actuation arm 60°. The actuation arm will end in a position that is easily seen from a distance, thus identifying the actuated unit. Two spring loaded detents riding on a hardened steel cam provide resistance to arm rotation. When the actuation force overcomes this resistance the assembly rotated the 60° and is locked in place by the detents. Affixed to the rotating shaft is a cam mechanism which actuates up to two micro switches during rotation. The micro switches are held in the actuated position by the detents.

To reset the unit and deactivate the micro switches, the actuation arm is pushed in a rotated backwards.

DETERMINATION OF NUMBER OF UNITS REQUIRED:

The Model RS control is designed so that a maximum of 100' of cable can be used on each side of the unit. A single switch can therefore cover a maximum of 200' of conveyor belt or other machinery. Of course, if necessary, cable can be extended in only one direction from either side of the unit. The electrical characteristics of the application will determine the numbers of micro switches to be specified in the unit: either one, or two. The environmental considerations will determine whether or not the unit is to be explosion proof or to have special paint or coatings. The possibility of a light to aid in identification of actuated units should be considered.

We recommend that high quality cable be used with the switch to assure proper actuation with no stretching. We recommend our own galvanized aircraft cable which is available with either vinyl or nylon coating. It is orange in color and weighs .0273 lbs. per foot and has an outside diameter of 3/16".

As shown in the chart and picture of the actuating arm, the actuation force can be varied by attaching the cable at any one of the three positions.



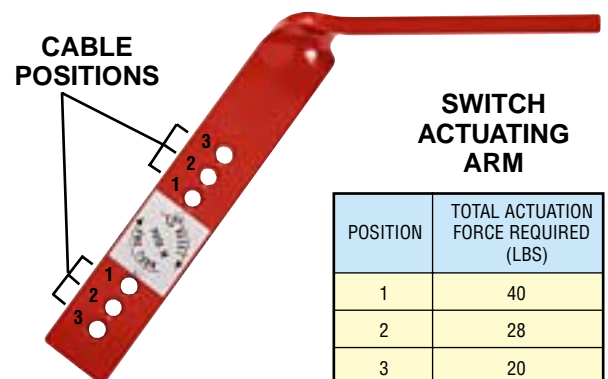



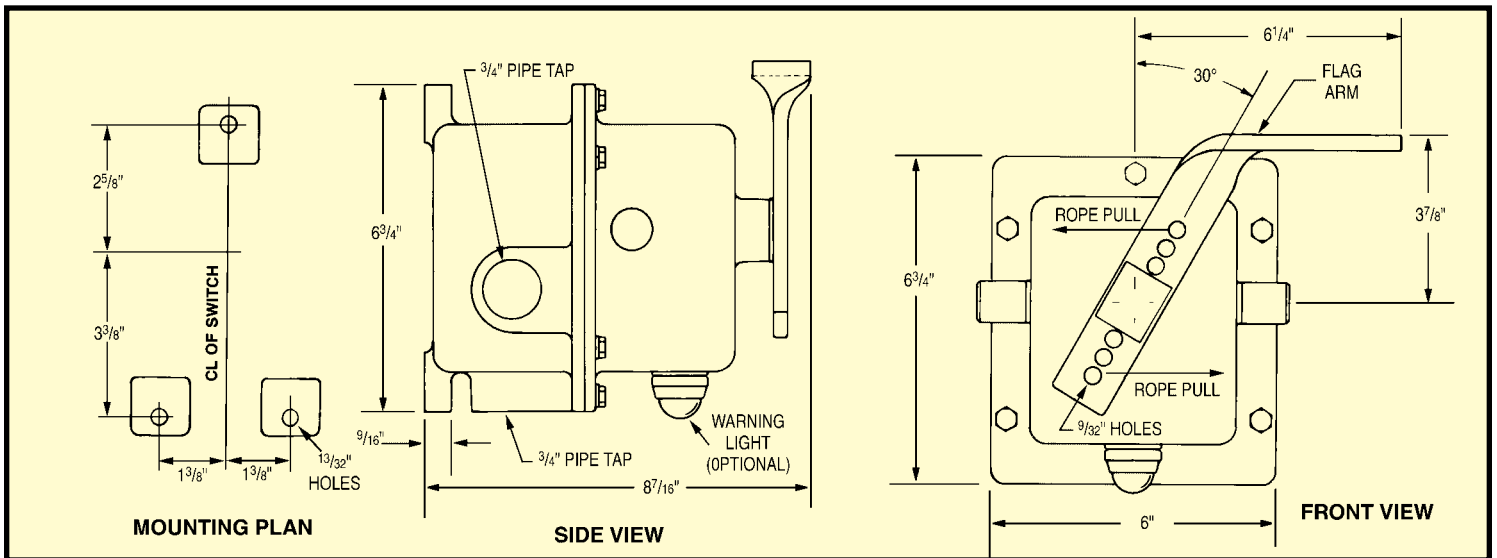



The cable should be supported by eyebolts every 8-10'. These supports ensure that the weight of the cable alone will not actuate the switch.



MODEL RS DIMENSIONAL INFORMATION



TECHNICAL INFORMATION

MODEL	DESCRIPTION
RS-1	One sp/dt micro switch  
RS-2	Two sp/dt micro switches  
RS-2L	Two sp/dt micro switches with external signal light includes 110V lamp  
RS-1X	Explosion proof with one sp/dt micro switch for NEMA 7 and 9  
RS-2X	Explosion proof with two sp/dt micro switches for NEMA 7 and 9  
RSB-1	One sp/dt switch w/cable break detection
RSB-1X	Explosion proof version
RSB-2	Two sp/dt switches w/cable break detection
RSB-2X	Explosion proof version

Standard Construction – rubber gaskets seal unit for outside applications listed by Underwriter Laboratories for for NEMA 4 dust-tight and raintight construction. Applies to units RS-1, RS-2, and RS-2L.

Housing – aluminum or cast iron. Epoxy coating available.

Conduit Opening – 3/4" NPT standard. 1" NPT optional. Standard units have three conduit openings., explosion proof have one at the bottom.

Actuating Arm – Red epoxy coated steel handle with stainless steel shaft.

Internal Cam and Wear Plate – hardened steel.

External Hardware – stainless steel

Switches – sp/dt micro switch. Rated 20 amp at 125, 250 or 480V AC. Switches may be wired for single throw operation, either normally open or normally closed as required.

INSTALLATION INSTRUCTIONS

1. The controls should be mounted on a flat surface using the three mounting holes on the bottom half of the housing. The holes are designed for 3/8" bolts.
2. Each switch can cover a maximum of 200' of conveyor — 100' in each direction. Safety considerations dictate that not more than 100' of cable be attached on each side. More cable might result in too much slack, delaying actuation.
3. The eyebolts supporting the cable should be placed at intervals from 8-10'. Care must be taken that the cable does not become too slack. However, if the cable is too tight, false actuation of the switch might occur.
4. The Model RS control is designed for pilot duty. The control circuit should be wired through the motor starter circuit of the conveyor or other equipment to be controlled. Do not wire the unit directly into a heavy duty motor circuit.
5. The unit should be tested after installation by actuation of the cable. The protected equipment should stop and alarms should sound as required with a minimum of effort on the cable. Cable tension can be adjusted if necessary by changing the location of the cable on the handle.



RS-30 BRACKET for mounting the Model RS stop switch to the conveyor stringer at an idler



OPTIONAL CABLE AND FITTINGS

